

Use and Care

Instructions

For your new



T2H Turgo
Micro-hydroelectric Generator



Models: MHG-T2H

READ THIS FIRST

This manual contains important information concerning your new PowerPal T2H Turgo micro-hydroelectric generator. It covers Model MHG-T2H. You should read this manual carefully before installing PowerPal or allow a trained technician from your local PowerPal Service Center to install it for you.

Your PowerPal generator is designed to be simple to operate and easy to maintain. If used in accordance with these instructions your PowerPal will give you many years of service. PowerPal is also designed with safety in mind, but any electric device can be dangerous if not used correctly. At several points in this manual, instructions requiring special attention that must be followed are shown as:



Warning symbol - beware of hazards or unsafe practices that may cause injury or death.



Caution symbol – beware of hazards or unsafe practices that may damage the product.

SAFETY FIRST



While electricity improves your life, it can also be dangerous if simple precautions are not followed:

- Never allow electrical contacts to become wet. Beware of electrocution.
- Never attempt to cut electrical wires or open appliances for repair if the generator is working. Unplug the main cable first.
- Inform children of the dangers of electrocution. Never allow them to play with electrical connections.
- Keep fingers away from the moving turbine runner. If partly blocked with debris, stop the water flow before cleaning.
- If you have any questions about safety, please ask your PowerPal Service Center.
- Product must be earth bonded (grounded).

OPERATING CAUTIONS



Your PowerPal generator is designed for simple operation and low maintenance. However, the following operating cautions must be followed to ensure a long life for PowerPal:

- Under conditions of higher water heads than given for each model in this manual, PowerPal is able to generate higher power outputs than rated. This can also occur if the intake pipe diameter exceeds the recommended diameter. If maximum power consumption listed in this manual is exceeded then the PowerPal generator may be irreparably damaged and require total rewiring. See the section on ‘Technical Specifications’.
- Do not forget to grease the bearings at the recommended times. Failure to do this will result in excessive wear on the bearings and shorten their life.

- Always ensure that the Electronic Load Controller is set at approximately 220V. Otherwise, the life of lights and appliances may be reduced.

POWERPAL COMPONENTS

Inside your PowerPal box you will find:

- 1 x generator-turbine assembly
- 1 x Pipe flange and rubber seal pad, internal diameter 110mm
- 1 x Shaft seal $\Phi 38 \times \Phi 58 \times 11$ for Spare
- 2 x Ring seal $\Phi 24 \times 3$ for Spare
- 6 x Bolts M8x40 and nuts
- 4 x M12x200 foundation nuts and bolts
- 1 x control panel including electronic load controller
- 2 x ballast load
- 1 x Guarantee Card
- 1 x This instruction manual.
- 1 x Pressure gauge. *Note: Pressure gauge gets the bend, and it's in front of turbine.*
- 1 x Valve of pressure meter. *Note: To the upper of valve where the water flows outside.*
- 1 x Remove runner.

Please advise immediately if any parts are missing. Complete your Guarantee Card and have it signed by your PowerPal dealer.

The PowerPal system consists of two major components – a hydroelectric generator and an electronic load controller. Other components are necessary and these can be purchased locally. The penstock (intake pipe) should be made from either steel or schedule 40 PVC. Your PowerPal dealer can advise you about this.

Therefore, other parts which are not included in the box but which are required to make PowerPal work are:

- a length of steel or PVC pipe with internal diameter 110mm. Pipe length will affect your power output (see page 5).
- electrical wire from generator to house. See the section on 'Technical Specifications' for the correct wire size.
- household wiring.

These are available from your dealer or local electrical store.

SYSTEM DIAGRAM

The following diagram shows how the non-electrical components fit together. Further reading of this manual will provide the necessary explanations. The components are:

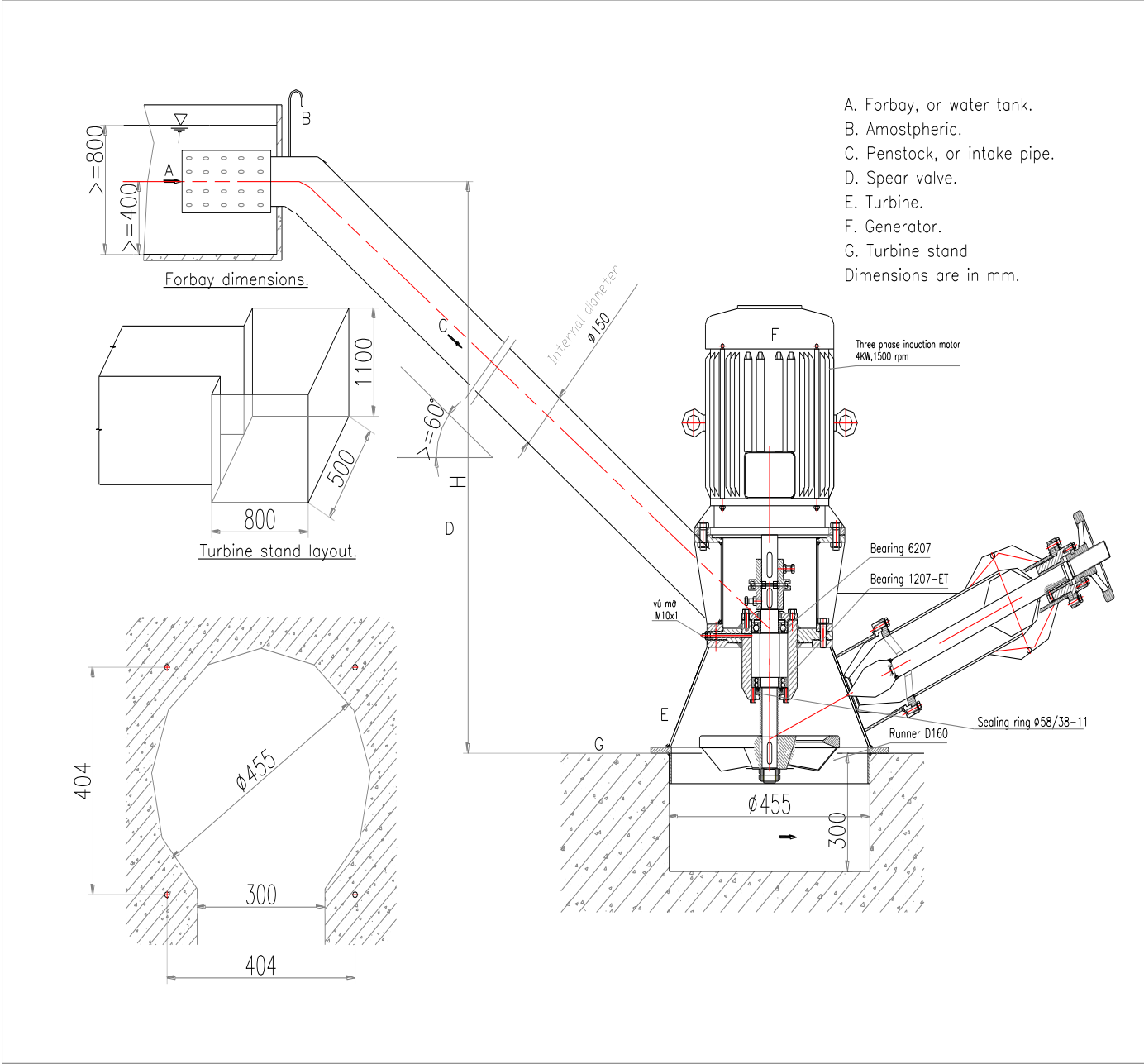

SELECTING A SITE

PowerPal is designed for use in a wide range of locations. There are two critical factors that influence power output – head and flow. Head is the vertical distance between the turbine and the water source (forebay), measured in meters. Flow is the amount of water that passes through the turbine at any instant, measured in litres per second (l/sec). The following table shows the various combinations of head and flow to achieve certain maximum power outputs for each model:

H (m)	24	26	28	30	32
Q (l/s)	25	25	25	25	25
Noutput (W)	1,991	2,498	2,750	3,231	3,587
U (V)	225	222	220	218	219
I (A)	8.85	11.25	12.5	14.82	16.38
n (rpm)	1.477	1.485	1.493	1.497	1.516

For example, if your site has available 32 meters of head and a water flow of 25 litres per second then a PowerPal MHG-T2H will produce up to 3.587Kw of electricity. Note that head and flow friction losses in the penstock have been incorporated into this table.

Measuring Gross Head

The gross head is the vertical height from where the water flow enters the penstock down to the level of the turbine. It is shown in the System Diagram. To measure this, use a tape measure and a clinometer or spirit level etc. A less accurate but useful alternative is to make your own level from a transparent tube half-filled with water. Attach this to the top of a 1m long stick and then point this horizontally at a point further up the slope as though it were a spirit level. By going to that point and repeating the process the total gross head can be measured – see the drawing below.

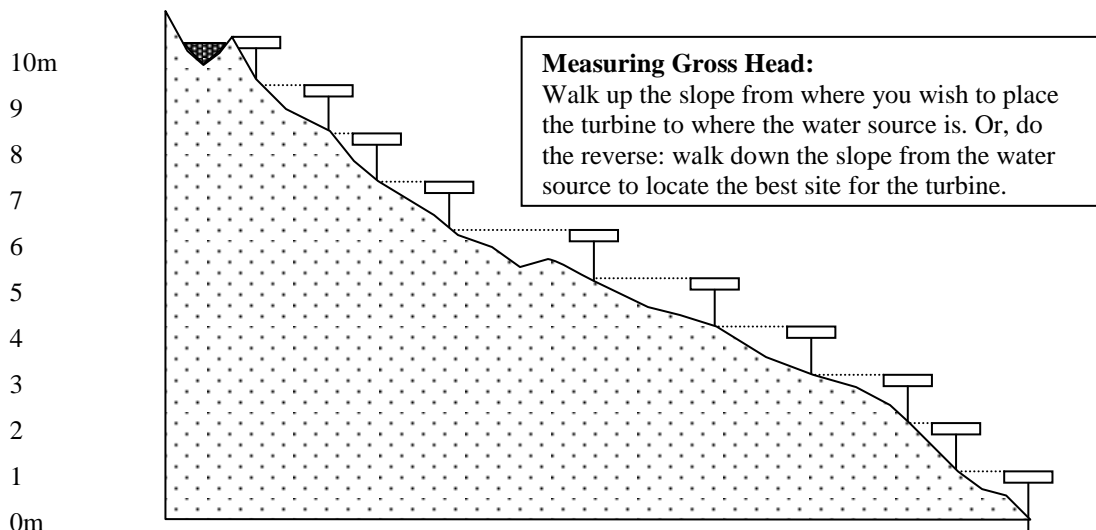

Another method is to use an accurate pressure gauge and a length of hose. Run a water-filled hose from the forebay to the turbine site and attach the pressure gauge to

the bottom end. The pressure gauge shows 1.422 psi / meter of head e.g. 11.4 psi for a head of 8m to 24.2 psi for a head of 17m.

This head should be between 24 and 34 meters for the MHG-T2H model. If it is smaller then the power output will be reduced. If it is larger then your power output will be increased. While increased power output appears desirable, if the head is too large then the rotor will turn too fast and reduce the life of the bearings unless the spear valve is used to reduce flow.



Do not attempt to exceed the recommended head height.

Measuring Flow

The best way to measure the water flow is to take a piece of pipe the same diameter as the penstock, insert it in the stream or dam where the flow is expected to come from, and measure the flow from there.

In the diagram below, a short length of pipe (less than 1 meter) is buried into the side of a small 'dam' using mud or improvised sandbags. The top end of the pipe is completely submerged and part of the normal stream flow is diverted through the pipe. When this is flowing smoothly, a bucket of known volume is quickly placed to collect this flow and the time it takes to fill the bucket is recorded. The ideal bucket size would be 100 or 200 litres (half or a whole empty oil drum), but smaller buckets will work. Divide the volume of the bucket (in litres) by the time it takes to fill the bucket (in seconds) to get the approximate flow rate in litres per second.

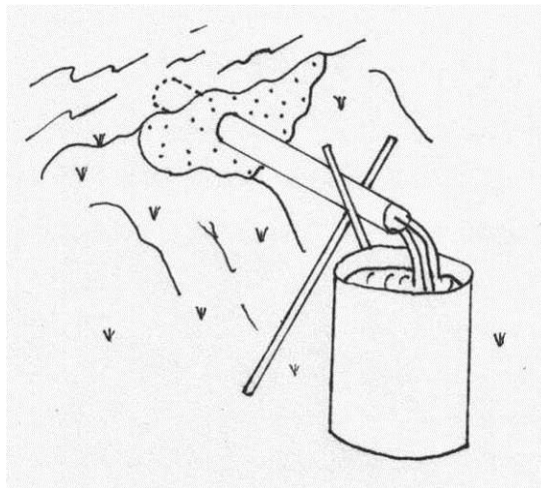

Measuring Flow:

$$\text{Flow} = \frac{\text{volume of bucket (litres)}}{\text{time to fill bucket (seconds)}}$$

SITE PREPARATION

Once the correct head and flow have been located then the length and position of the penstock can be determined. While vertical head is important, the horizontal slope and penstock length may vary although penstock inclination should be $>60^\circ$.

The penstock should be made of PVC or steel with internal diameter of 110mm and thickness of at least 3mm. A larger diameter pipe can be used however this is

generally more costly. A gate valve is a good idea and may be installed at the high-

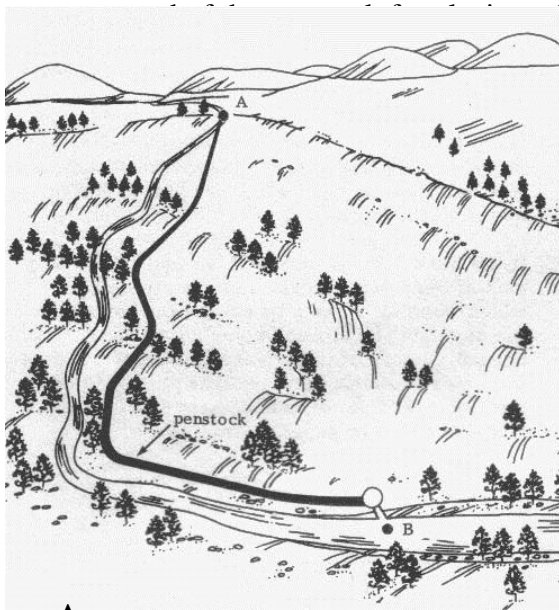

A

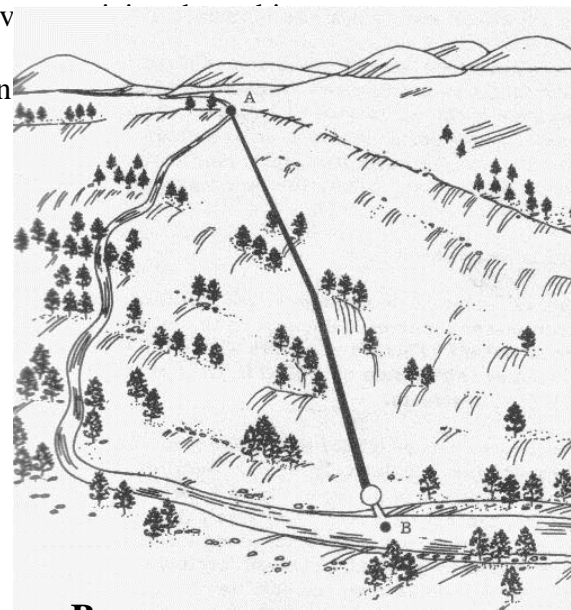

B

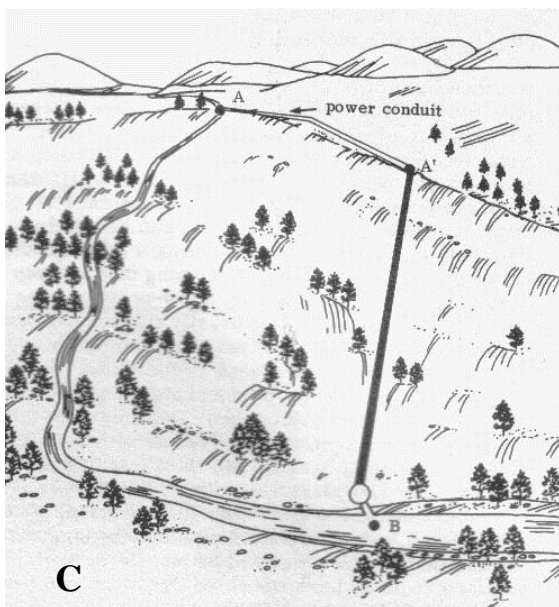

C

The penstock is shown by the black line A-B. In the first diagram (A) the penstock follows the stream. This may lead to unnecessary length and cost. In diagram B, the most direct route is selected to reduce length and cost. Diagram C shows the best alternative where a side channel or 'power conduit' is cut into the side of the hill. This carries the water to a point as close to above the turbine as possible and best reduces the length of penstock required.

The power conduit roughly follows the hill's contour and need only be a simple ditch say 30cm x 30cm in section.

When installing the penstock, try to keep it as straight as possible and avoid sharp turns or angles. To do this, part of the hillslope may need excavating while in other places the penstock may need supporting with poles etc. Steeper terrain has advantages over more gentle terrain as cost is reduced by the use of a shorter penstock.

The forebay, or water holding tank at the top of the penstock is designed to contain a water volume of at least 2.5x the volume of water in the penstock i.e. 440 litres. Dimensions of the ideal design are shown in the system diagram although the main point is to ensure that the forebay won't become empty.

The top of the penstock is typically placed not at the bottom but some way up the forebay wall so that the bottom of the forebay acts as a sink for rotting leaf litter, deposited sand and mud etc. This sink may need periodic cleaning out. Another good

idea is to cover the end of the penstock with a piece of wire mesh (debris screen) to keep leaves etc. from flowing in and clogging the turbine. See Appendix A for the ideal forebay design.

SYSTEM INSTALLATION

Mechanical Aspects

After locating a suitable site and completing the civil works, your PowerPal is ready for installation. To do this:

1. Bolt the turbine to a turbine stand or base which allows at least 300mm clearance between the turbine and the ground. This clearance is required to prevent splashback that will disrupt turbine performance. The turbine stand should be made from concrete with the four M12 foundation bolts embedded. Bolt spacing is shown in the system diagram but check this against the turbine casing.
2. Turn the handle of the spear valve until the valve is fully closed.



Always turn the handle slowly and smoothly.

3. Affix an elbow bend into the forebay wall. This should be fitted with an atmospheric vent (hollow bent pipe), which allows air to escape from the penstock. The upper opening of the atmospheric vent should be higher than the water level in the forebay. Divert water away from the forebay or else block the top of the penstock pipe during the installation procedure.
4. Affix a suitable elbow bend to the turbine to allow its connection to the penstock. A gate valve may also be installed at this point, if required.
5. Start installing the penstock. Assembly can begin from either direction but it is usually easier to begin uphill – the turbine is much easier to move around than the forebay is. The penstock should be well secured i.e. strongly supported with periodic anchors or buried at regular intervals to support its weight when full – this is particularly important at any bends and at the bottom of the penstock so that PowerPal cannot be knocked over. At least two people should handle the penstock, one uphill and one downhill, until it is fitted into both elbow bends.

Electrical Aspects

The generator is a double-winding, capacitive, modified 3-phase induction motor which has zero-load voltage built up by residual magnetism. Its direction of rotation is clockwise when viewed from the generator end. It has been modified to produce single-phase electrical power. This conversion takes place in the control box. Load is controlled by an electronic load controller (ELC) which is installed as part of the control box. The ELC is designed to maintain constant voltage by keeping a constant power on the generator output. To do this, the ELC switches any power not being used by the consumer to a ballast load (supplied) where the surplus energy is burnt off

as heat. The ELC is wired in parallel with the generator output so that it can't be inadvertently switched out of the circuit. The system is connected as follows:

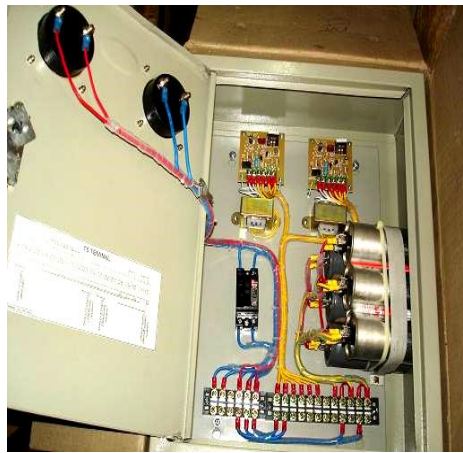
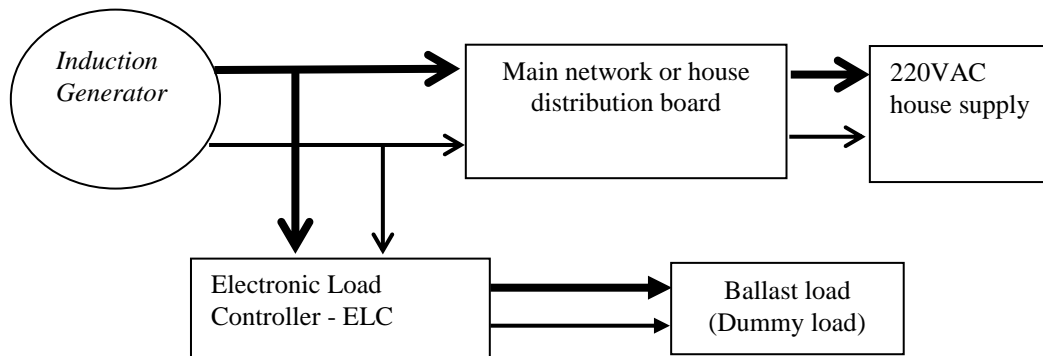

To connect the electrical components, please follow these steps:



The electrics should be installed by persons competent in mains voltage wiring. This system operates on a switched neutral basis. Neutral and phase connections to the load elements should be treated as live at all times!

1. Install the control box (A) in a convenient location that is protected from rain and sun. This may be either in a powerhouse along with the turbine or else in a house at the user's end.
2. Earth-bond (ground) PowerPal. Do this by attaching one end of a suitable length of wire to PowerPal and the other end to a metal object or metal stake in the ground nearby PowerPal. Although the risk of electric shock is already low, this earth-bonding is still best practice.
3. Connect the generator to the control box (B). All wiring from the generator to the control box, from the control box to the user load and from the control box to the ballast load should be done using insulated multistrand copper wire, the size of which is given in the Technical Specifications part of this manual. The following wiring diagram applies:

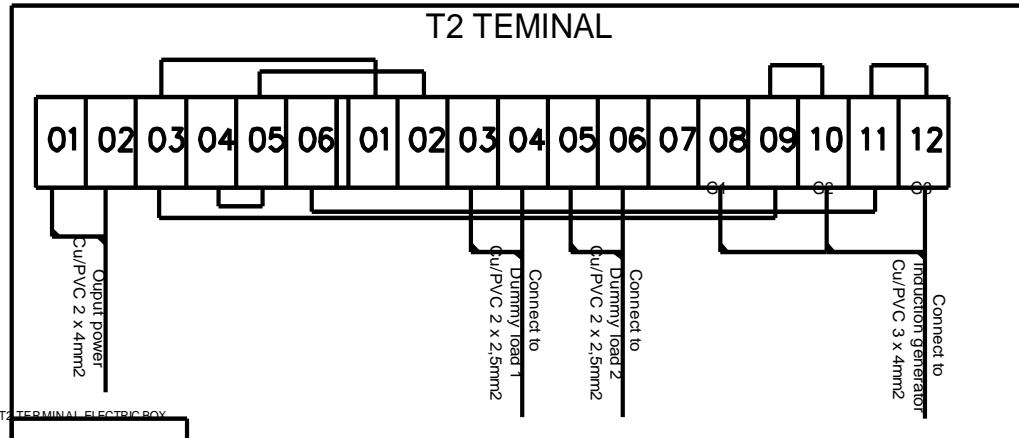

4. Connect the user load cables pin 01 and pin 02 (of terminal 1) between the control box and the house.
5. Connect the ballast load (C) to the control box and user load cable. The ballast load is rated 10-15% (maximum) higher than the rated power output of the generator e.g. 2.0kW for model MHG-T2H. As such, it will become hot, up to 100°C. To prevent injury and the risk of fire, the ballast load must be installed in a safe place and preferably in an additional enclosure.
6. Close the generator terminal box and the control box door. The system is now ready for its first operation.

OPERATION

1. Check that the power conduit and forebay are free of debris.
2. Ensure that the turbine is shut down and that all supply lines are electrically dead. The switch on the door of the control box must be in the 'off' position.
3. Fill the forebay and allow the water to flow gradually into the penstock. The spear valve should be fully closed, then backed out one full turn at this stage. The turbine runner will rotate and spent water will escape through the floor of the platform.
4. As the water flow starts to create electric power, the voltage will rise until the voltmeter on the control box reads 230V. Once this occurs, turn the control box switch to the 'on' position and then adjust the water flow with the spear valve so that the voltage stays at 230V. The voltage will then fall down after some seconds. When it happens, opening spare valve to adjust water through turbine, look at

voltmeter on the panel is increasing. Turn this valve until its value is 220V then stop.

5. Operate like this for 15 minutes while observing any unusual noise, excessive temperature or other problems and if OK then switch on the power to the user. Up till now the ballast load has been receiving all the power and should be hot, but once switching on the user load the power to the ballast load will fall.
6. The voltage should remain stable as loads are switched on or off. If the voltage falls below 220V then check the water flow conditions. The voltage may need to be checked and adjusted if the water flow rate changes e.g. a prolonged dry period may gradually reduce it.
7. Connect true, when ampe phase G1, G2 \leq ampe on the mark induction generator.



Do not allow electrical contacts to become wet. Use dry hands. Beware of electrocution.



Avoid plugging appliances directly into PowerPal without using the load controller. Incorrect voltage may result, which can damage your appliance.

8. Whenever shutting down the system, first close the valve to reduce the flow rate and once the voltmeter shows 100V, switch the control box to the 'off' position. Then close the valve fully to stop the system.

CARE AND MAINTENANCE

General care for your PowerPal will enhance its life. Following the instructions in this manual is important.

Try to install PowerPal in a place that is unlikely to be flooded. A simple shelter with a roof will also help protect the generator from rain or else a small shed can be built and locked if security is an issue. If the inside of the generator assembly does become wet it will require drying. No permanent damage will result, but check the bearings to see if they have collected water. Do not try to dry it near a fire. Before using again, make sure that the power socket is also dry. Condensation inside the generator is normal in tropical areas and will not affect the performance of PowerPal.

Greasing the Bearings

PowerPal has three bearings, two in the generator and one in the turbine. The generator bearings are maintenance-free while the turbine bearing has been greased in the factory ready for use but requires re-greasing every 3 months of continuous use. To do this, clean the nipple on the bearing casing and apply extra grease with a grease gun. There is no need to stop the turbine to grease this bearing.



Failure to grease the bearings on time will shorten their life and require their replacement. The increased friction will also reduce power output. Always clean the nipple before greasing.

Changing the Bearings and Seal

Apart from greasing the bearing, there are only two tasks that must be completed at regular intervals. These are the changing of the lower generator bearing & turbine bearing and the lower bearing seal every two years. See the section on Technical Specifications at the end of this manual for part numbers. These are commonly available in most countries but if in doubt contact your dealer. To replace the bearings and seal, follow these steps:

1. Shut down the system and disconnect the power cable at the generator.
2. Drain the forebay so that the water flow stops. Do not simply block the top of the penstock. Leave the spear valve open.
3. Wait till the penstock is drained i.e. little or no water flows out of the turbine.
4. Disconnect the turbine from the penstock
5. Unbolt the turbine and remove from the turbine stand.
6. Turn PowerPal on its side (photo A).
7. Unbolt and remove the runner (photo B).
8. Unbolt and remove the generator from the turbine casing (photo C).
9. Unbolt and remove the turbine bearing casing (photo D).
10. The turbine bearing is now visible (photo E) above the seal. Remove these using a bearing removal tool. The seal is a black rubber ring (center of photo F) and is there to prevent water entering the generator.
11. Before replacing the bearing ensure that the casing is clean and greased (photo F).
12. To replace the lower generator bearing, disconnect the bearing housing and use a bearing removal tool.
13. When reassembling, make sure that all parts are correctly in place and that all bolts are tightened.
14. After PowerPal has been securely reconnected to the turbine stand and penstock adaptor flange the forebay is refilled and normal water flow is allowed to continue. Wait until this occurs before reconnecting the cable and appliances.

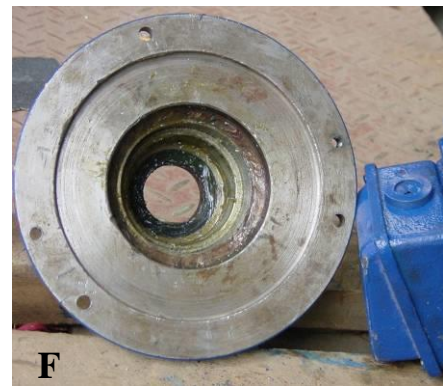

TROUBLESHOOTING

If any problems are encountered, check this section before contacting your Service Center.

1. *Head and flow conditions appear to be OK, but PowerPal will not work.*

It is likely that the system has been installed incorrectly. Check this by following the steps once more.

2. *PowerPal has provided electricity for a while and suddenly the electricity stops.*

If this instruction manual is not followed and power consumption is too high, or if there is a short circuit in an appliance the circuit breaker in the electronic load controller will trip. This will stop the electric current. If this occurs, check for possible causes and rectify. Reset the switch on the circuit breaker to the 'on' position.

3. *Voltage is 220V under zero-load conditions but falls when a load is applied.*

Either a capacitor in the control box has been damaged or excessive load has been applied. Reduce the load consumption to see if voltage stabilizes and if not have the control box examined by a competent electrician.

4. *Testing in the stream showed that PowerPal was capable of producing the rated output power (1000W or 2000W, depending on model). However, after running the electrical cable to the house this output power was found to be less.*

Due to resistance from the cable, long cable runs will result in a small loss of output power. Power loss over a 100m cable run is approximately 10W. For log wire runs it is possible to install a 4.75~10 μ f capacitor at the load end or otherwise to increase the cable diameter.

5. *Power output has been falling recently.*

Falling output suggests that the turbine is rotating more slowly than usual. Make sure that the enough water is entering the forebay and ensure that the source river is adequate for the flow being consumed. Otherwise, check the forebay and penstock filter and clean if necessary. There may be soft organic debris such as rotten leaves restricting the spear valve. Try running the valve completely closed and completely open one or two cycles. This may clear the valve of any foreign material and open it up to full power again. If that happens, then you should go to the forebay and be sure that it is clean, and eliminate the cause that allowed the foreign material into the pipeline in the first place. You can also check that the runner is free of leaves and other debris and that the turbine bearing has enough grease. Under certain conditions the generator may lose magnetism and result in loss of power. Its main winding may be re-magnetized by applying a 3V DC power source and energizing for approximately 30 seconds.

6. *On starting, the control panel shows 220-240 volts and zero amps. The circuit breaker has been turned "on" with the user load "off." No power goes to the ballast resistor.*

Check the voltage at the right side of the transformer; it should be 220-240 volts. Check voltage at the left side of the transformer, it should be 18-25 volts. If not, the transformer is faulty. If yes, check the voltage at the terminals at the top of the circuit board. This should be 18-25 volts. Check the voltage at the terminals at the bottom of the circuit board. This should be AC, low voltage. If there are 18-25 volts at the top of the circuit board and no voltage at the bottom of the circuit board, then something in the circuit board is faulty. If that is the case, try adjusting the potentiometer as follows:

a) Start the generator and adjust the spear valve to obtain 220-240 volts, 0 amps at the panel. [Do not turn the circuit breaker on].

- b) Adjust the potentiometer on the circuit board very slowly to the left. When you detect a small decrease in voltage, stop. Turn on the circuit breaker and increase water to increase power to the unit. Increase power until a load of 3kW is indicated ($P = VI$).
- c) If adjusting the potentiometer does not correct the problem, then contact PowerPal. The problem is probably with the potentiometer.

TECHNICAL SPECIFICATIONS

MHG-T2H

1	Rated power output	3000W
2	Maximum allowable load	3500W
3	Intended voltage	220V~
4	Frequency at rated power output	50 Hz
5	Frequency at runaway speed	70 Hz
6	Runaway speed	2250rpm
7	Height	720mm
8	Weight	150kg
9	Turbine runner type	Turgo
10	Runner diameter	160mm
11	Number of buckets	20
12	Number of nozzles	1
13	Generator	3- phase induction
14	Generator insulation	Class B
15	Protection grade	IP44
16	Load controller circuit breaker	20A
17	Upper generator bearing size	6205-2Z
	Lower generator bearing size	6206-2Z
	Lower Turbine bearing size	SKF 1207-ET
	Upper Turbine bearing size	SKF 6207 – 2Z
18	Seal size	38x58x11mm
19	Recommended cable	4mm ²
20	Operating temperature	5 to 50 ° C
21	Operating humidity	0 to 90%

Notes:

1, 2. Rated power output is the manufacturer's specified output for the given head and flow conditions. A higher output is possible if the head is greater or the flow is faster than recommended. If the maximum allowable load is exceeded then permanent damage to the stator may occur.

3. Is approximately 220V when the ELC is used?

5,6. Runaway speed is the speed of the rotor if no load is applied. This speed is reduced under load.

18. We recommend SKF brand or similar high quality bearings.

Also, the diagrams and much useful information on pages 7 and 16 are taken from *Micro-hydropower Sourcebook – A Practical Guide to Design and Implementation in Developing Countries*. NRECA, 1986.

APPENDIX A – FOREBAY DESIGN

The instructions given on page 7 of this manual to design the forebay are adequate for most cases. The most important aspects of forebay design are:

- 1) To allow a continual flow of water to the penstock so that the turbine keeps functioning.
- 2) To have sufficient safeguards to prevent sand, vegetation and other debris from entering the penstock which could cause blockages and disrupt the turbine. This includes a safety aspect to keep away children and animals that could possibly be injured by the suction of water entering the penstock.
- 3) To have an easy way to stop the water flow when changing the bearings etc.

The following diagram shows a simple forebay design that may be used to achieve all the above goals.

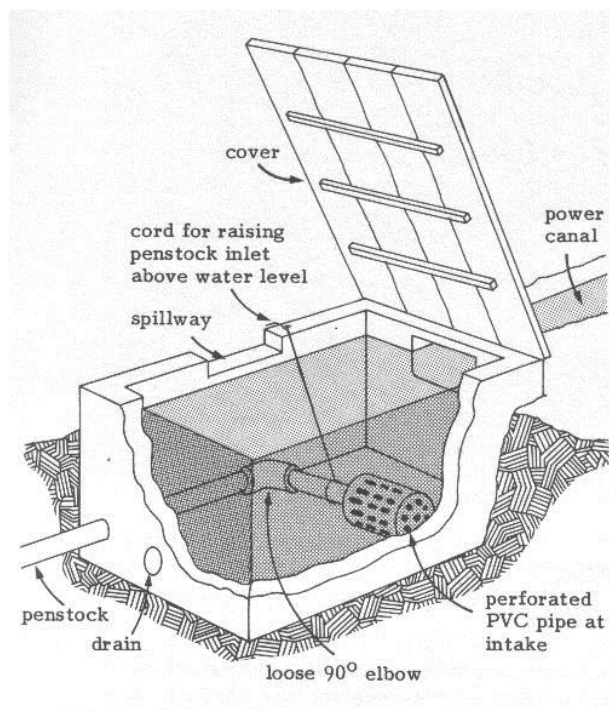

Here, the forebay is made of a waterproofed box situated between the power canal (power conduit) and the penstock. A loosely fitting elbow is inserted between the penstock inlet and the main penstock pipe. Flow to the penstock is cut off by pulling the cord so that the inlet is out of the water. The plugged drain is used to periodically empty out sand and leaves or else this can be shoveled out. The perforated pipe end further reduces litter intake. Here the number of holes is important so that flow is not obstructed. To allow optimal, uninterrupted flow, the open part of the inlet screen should be at least four times the open area of

the penstock. For example, if using the recommended 110mm diameter penstock then 95 x 1cm diameter holes should be drilled into the inlet screen (or 380 x 0.5cm diameter holes etc.). The length of the inlet screen doesn't matter, so long as the minimum number of holes can be added. Bore casing with narrow, long slits is ideal.

The cover will help keep the forebay clean and may be locked to keep away children.